

Model: **VTLF2.400**

SPECIFICATIONS

Volume flow 50 Hz	390 m ³ /h
Vacuum absolute 50 Hz	200 mbar
Power 50 Hz	7.5 kW
Noise Level 50 Hz	77.0 dB(A)
Volume flow 60 Hz	460 m ³ /h
Vacuum absolute 60 Hz	200 mbar
Power 60 Hz	9.0 kW
Noise Level 60 Hz	79.0 dB(A)
Weight	248.0 kg without motor

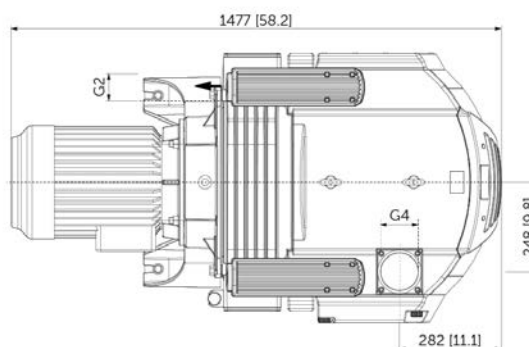
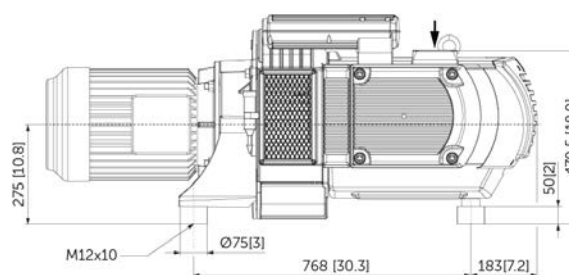
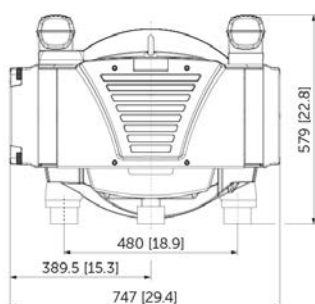

mm [inch]

BECKER VTLF 2.400